

## Aluminum Electrolytic Capacitors SMD (Chip), High Temperature

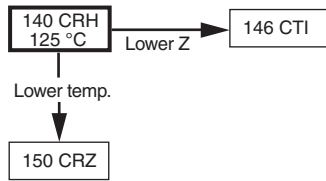

Fig. 1

 AUTOMOTIVE  
GRADE

**RoHS**  
COMPLIANT

### FEATURES

- Extended useful life: up to 6000 h at 125 °C for MAL214099...E3 parts
- Parts for advanced high temperature reflow soldering according to JEDEC® J-STD-020 available
- Vibration proof, 4-pin version and 6-pin version
- AEC-Q200 qualified
- Polarized aluminum electrolytic capacitors, non-solid electrolyte, self healing
- SMD-version with base plate, lead (Pb)-free reflow solderable
- Charge and discharge proof, no peak current limitation
- High reliability
- Material categorization: for definitions of compliance please see [www.vishay.com/doc?99912](http://www.vishay.com/doc?99912)

### APPLICATIONS

- SMD technology, for high temperature reflow soldering
- Industrial and professional applications
- Automotive, general industrial, telecom
- Smoothing, filtering, buffering

### MARKING

- Rated capacitance (in  $\mu\text{F}$ )
- Rated voltage (in V)
- Date code, in accordance with IEC 60062
- Black mark or “-” sign indicating the cathode (the anode is identified by beveled edges)
- Code indicating group number (H)

### PACKAGING

Supplied in blister tape on reel

QUICK REFERENCE DATA	
DESCRIPTION	VALUE
Nominal case sizes (L x W x H in mm)	8 x 8 x 10 to 18 x 18 x 21
Rated capacitance range, $C_R$	10 $\mu\text{F}$ to 4700 $\mu\text{F}$
Tolerance on $C_R$	$\pm 20\%$
Rated voltage range, $U_R$	6.3 V to 63 V
Category temperature range	-55 °C to +125 °C
Endurance test at 125 °C	1000 h to 5000 h
Useful life at 125 °C	1500 h to 6000 h
Useful life at 40 °C 1.8 x $I_R$ applied	150 000 h to 500 000 h
Shelf life at 0 V, 125 °C	1000 h
Based on sectional specification	IEC 60384-18 / CECC 32300
Climatic category IEC 60068	55 / 125 / 56

SELECTION CHART FOR $C_R$ , $U_R$ , AND RELEVANT NOMINAL CASE SIZES (L x W x H in mm)							
$C_R$ ( $\mu F$ )	$U_R$ (V)						
	6.3	10	16	25	35	50	63
10	→	→	→	→	→	→	8 x 8 x 10
22	→	→	→	→	→	→	8 x 8 x 10
33	→	→	→	→	→	→	8 x 8 x 10
47	→	→	→	→	→	8 x 8 x 10	10 x 10 x 10
68	→	→	→	→	8 x 8 x 10	10 x 10 x 10	10 x 10 x 14
100	→	→	→	8 x 8 x 10	10 x 10 x 10	10 x 10 x 14	12.5 x 12.5 x 13
150	→	→	8 x 8 x 10	→	10 x 10 x 14	-	-
220	→	8 x 8 x 10	→	10 x 10 x 10	12.5 x 12.5 x 13	12.5 x 12.5 x 13	12.5 x 12.5 x 16
330	8 x 8 x 10	10 x 10 x 10	10 x 10 x 14	12.5 x 12.5 x 13	12.5 x 12.5 x 13	12.5 x 12.5 x 16	16 x 16 x 16
							16 x 16 x 21
							18 x 18 x 16
470	10 x 10 x 10	10 x 10 x 14	12.5 x 12.5 x 13	12.5 x 12.5 x 16	12.5 x 12.5 x 16	16 x 16 x 16	16 x 16 x 21
							18 x 18 x 16
							18 x 18 x 21
680	10 x 10 x 14	12.5 x 12.5 x 13	12.5 x 12.5 x 16	→	16 x 16 x 16	16 x 16 x 21	
						18 x 18 x 16	
820	→	→	→	→	16 x 16 x 21	18 x 18 x 16	
						18 x 18 x 21	
1000	→	12.5 x 12.5 x 16	16 x 16 x 16	16 x 16 x 16	18 x 18 x 16	18 x 18 x 21	-
			16 x 16 x 21	16 x 16 x 21			-
1200	→	→	→	→	18 x 18 x 21	-	-
1500	→	→	16 x 16 x 16	16 x 16 x 21	18 x 18 x 21	-	-
			18 x 18 x 16	18 x 18 x 16			
2200	→	16 x 16 x 16	16 x 16 x 21	18 x 18 x 21	-	-	-
			18 x 18 x 21	-			
3300	→	16 x 16 x 21	18 x 18 x 21	-	-	-	-
		18 x 18 x 16	-	-	-	-	-
4700	→	18 x 18 x 21	-	-	-	-	-

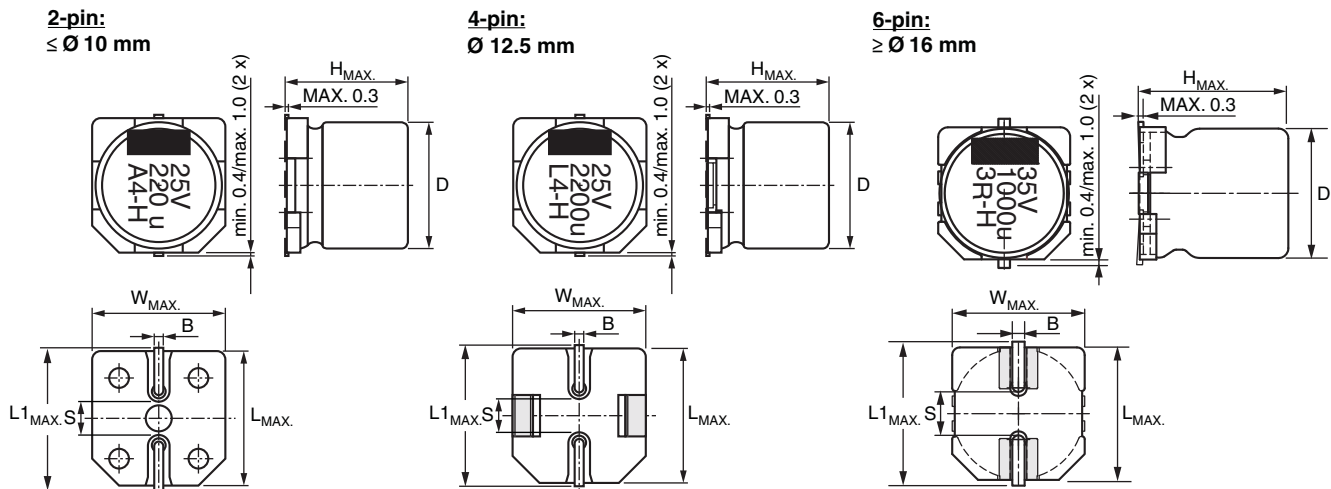

Fig. 2 - Dimensional outline



Table 1

<b>DIMENSIONS</b> in millimeters <b>AND MASS</b>									
NOMINAL CASE SIZE L x W x H	CASE CODE	L <sub>MAX.</sub>	W <sub>MAX.</sub>	H <sub>MAX.</sub>	Ø D	B <sub>MAX.</sub>	S	L <sub>1MAX.</sub>	MASS (g)
8 x 8 x 10	0810	8.5	8.5	10.5	8.0	1.0	2.2	10.2	≈ 1.0
10 x 10 x 10	1010	10.5	10.5	10.5	10.0	1.0	3.5	12.1	≈ 1.3
10 x 10 x 14	1014	10.5	10.5	14.3	10.0	1.0	3.5	12.1	≈ 1.5
12.5 x 12.5 x 13	1213	12.9	12.9	14.0	12.5	1.3	3.6	14.9	≈ 2.6
12.5 x 12.5 x 16	1216	12.9	12.9	16.5	12.5	1.3	3.6	14.9	≈ 2.8
16 x 16 x 16	1616	16.6	16.6	17.5	16.0	1.3	6.5	18.6	≈ 5.5
16 x 16 x 21	1621	16.6	16.6	22.0	16.0	1.3	6.5	18.6	≈ 6.0
18 x 18 x 16	1816	19.0	19.0	17.5	18.0	1.3	6.5	21.0	≈ 8.0
18 x 18 x 21	1821	19.0	19.0	22.0	18.0	1.3	6.5	21.0	≈ 8.3

Table 2

<b>TAPE AND REEL DIMENSIONS</b> in millimeters, <b>PACKAGING QUANTITIES</b>						
NOMINAL CASE SIZE L x W x H	CASE CODE	PITCH P <sub>1</sub>	TAPE WIDTH W	TAPE THICKNESS T <sub>2</sub>	REEL DIAMETER	PACKAGING QUANTITY PER REEL
8 x 8 x 10	0810	16	24	11.6	380	500
10 x 10 x 10	1010	16	24	11.6	380	500
10 x 10 x 14	1014	16	24	15.4	330	250
12.5 x 12.5 x 13	1213	20	24	16.2	380	250
12.5 x 12.5 x 16	1216	24	32	18.5	380	200
16 x 16 x 16	1616	28	44	18.9	380	150
16 x 16 x 21	1621	28	44	23.4	380	100
18 x 18 x 16	1816	32	44	18.9	380	125
18 x 18 x 21	1821	32	44	23.4	380	100

**Note**

- For detailed tape dimensions please refer to packaging information: [www.vishay.com/doc?28359](http://www.vishay.com/doc?28359)

**MOUNTING**

The capacitors are designed for automatic placement on to printed-circuit boards.

Optimum dimensions of soldering pads depend amongst others on soldering method, mounting accuracy, print layout and / or adjacent components.

For recommended soldering pad dimensions, refer to Fig. 3 and Table 3.

**SOLDERING**

Soldering conditions are defined by the curve, temperature versus time, where the temperature is that measured on the component during processing.

For maximum conditions refer to Fig. 4 or Fig. 5.

Any temperature versus time curve which does not exceed the specified maximum curves may be applied.

As a general principle, temperature and duration shall be the **minimum** necessary required to ensure good soldering connections. However, the specified maximum curves should never be exceeded.



Fig. 3 - Recommended soldering pad dimensions

Table 3

RECOMMENDED SOLDERING PAD DIMENSIONS in millimeters						
CASE CODE	a	b	c	d	e	f
0810	4.4	2.5	3.0	-	-	-
1010	4.4	2.5	4.0	-	-	-
1014	4.4	2.5	4.0	-	-	-
1213	6.3	2.5	4.0	4.2	5.0	5.6
1216	6.3	2.5	4.0	4.2	5.0	5.6
1616	7.8	9.6	4.7	-	-	-
1621	7.8	9.6	4.7	-	-	-
1816	8.8	9.6	4.7	-	-	-
1821	8.8	9.6	4.7	-	-	-

**STANDARD SOLDERING PROFILE FOR LEAD (Pb)-FREE REFLOW PROCESS**

Fig. 4 - Maximum temperature load during reflow soldering

**Table 4**

<b>REFLOW SOLDERING CONDITIONS</b> for MAL214097xxxE3		
<b>PROFILE FEATURES</b>	<b>CASE CODE 0810 TO 1014</b>	<b>CASE CODE 1213 TO 1216</b>
Max. time from 25 °C to $T_{Peak}$	240 s	200 s
Max. ramp-up rate to 150 °C	3 K/s	3 K/s
Max. time from 150 °C to 200 °C ( $t_1$ )	150 s	120 s
Ramp up rate from 200 °C to $T_{Peak}$	0.5 K/s to 3 K/s	0.5 K/s to 3 K/s
Max. time from 200 °C to 217 °C ( $t_2$ )	60 s	60 s
Max. time above $T_{Liquidus}$ (217 °C) ( $t_3$ )	90 s	60 s
Max. time above 230 °C ( $t_4$ )	40 s	30 s
Peak temperature $T_{Peak}$	250 °C	240 °C
Max. time above $T_{Peak}$ minus 5 °C	5 s	10 s
Max. ramp-down rate from $T_{Liquidus}$	3 K/s to 6 K/s	3 K/s to 6 K/s

**Notes**

- Temperature measuring point on top of the case and on terminals
- Max. 2 runs with pause of min. 30 min in between

**ADVANCED SOLDERING PROFILE FOR LEAD (Pb)-FREE REFLOW PROCESS  
ACCORDING TO JEDEC J-STD-020**

Fig. 5 - Maximum temperature load during reflow soldering

**Table 5**

<b>REFLOW SOLDERING CONDITIONS</b> for MAL214099xxxE3			
<b>PROFILE FEATURES</b>	<b>CASE CODE 1010</b>	<b>CASE CODE 1213 TO 1216</b>	<b>CASE CODE 1616 TO 1821</b>
Max. time from 25 °C to $T_{Peak}$	300 s	300 s	300 s
Max. ramp-up rate to 150 °C	3 K/s	3 K/s	3 K/s
Max. time from 150 °C to 200 °C ( $t_1$ )	150 s	150 s	150 s
Max. time from 190 °C to 200 °C ( $t_2$ )	110 s	110 s	110 s
Ramp up rate from 200 °C to $T_{Peak}$	0.5 K/s to 3 K/s	0.5 K/s to 3 K/s	0.5 K/s to 3 K/s
Max. time above $T_{Liquidus}$ (217 °C) ( $t_3$ )	90 s	90 s	90 s
Max. time above 230 °C ( $t_4$ )	70 s	65 s	60 s
Peak temperature $T_{Peak}$	260 °C	250 °C	245 °C
Max. time above $T_{Peak}$ minus 5 °C	40 s	30 s	30 s
Ramp-down rate from $T_{Liquidus}$	3 K/s to 6 K/s	3 K/s to 6 K/s	3 K/s to 6 K/s

**Notes**

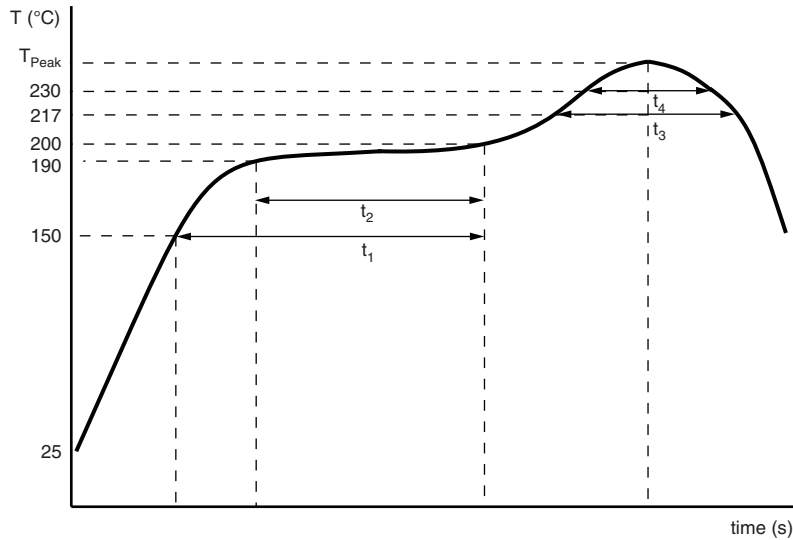
- Temperature measuring point on top of the case and on terminals
- Max. 2 runs with pause of min. 30 min in between



ELECTRICAL DATA	
SYMBOL	DESCRIPTION
C <sub>R</sub>	Rated capacitance at 100 Hz, tolerance ± 20 %
I <sub>R</sub>	Rated RMS ripple current at 100 kHz, 125 °C
I <sub>L2</sub>	Max. leakage current after 2 min at U <sub>R</sub>
tan δ	Max. dissipation factor at 100 Hz
Z	Max. impedance at 100 kHz

**ORDERING EXAMPLE**

Electrolytic capacitor 140 CRH series

220 µF / 50 V; ± 20 %

Nominal case size: 12.5 mm x 12.5 mm x 13 mm; taped on reel

Ordering code: MAL214099111E3

**Note**

- Unless otherwise specified, all electrical values in Table 6 apply at T<sub>amb</sub> = 20 °C, P = 86 kPa to 106 kPa, RH = 45 % to 75 %

Table 6

ELECTRICAL DATA AND ORDERING INFORMATION									
U <sub>R</sub> (V)	C <sub>R</sub> (µF)	NOMINAL CASE SIZE L x W x H (mm)	I <sub>R</sub> 100 kHz 125 °C (mA)	I <sub>L2</sub> 2 min (µA)	tan δ 100 Hz	Z 100 kHz 20 °C (Ω)	LIFE CODE <sup>(3)</sup>	ORDERING CODE <sup>(1)</sup> MAL2140...	ORDERING CODE <sup>(2)</sup> MAL2140...
6.3	330	8 x 8 x 10	180	21	0.30	0.40	L1	97303E3	-
	470	10 x 10 x 10	300	30	0.30	0.25	L1	97301E3	-
	470	10 x 10 x 10	300	30	0.30	0.25	L1	-	99301E3
	680	10 x 10 x 14	430	43	0.30	0.20	L1	97302E3	-
10	220	8 x 8 x 10	180	22	0.26	0.40	L1	97403E3	-
	330	10 x 10 x 10	300	33	0.26	0.25	L1	97401E3	-
	330	10 x 10 x 10	300	33	0.26	0.25	L1	-	99401E3
	470	10 x 10 x 14	430	47	0.26	0.20	L1	97402E3	-
	680	12.5 x 12.5 x 13	750	68	0.22	0.12	L2	97411E3	-
	680	12.5 x 12.5 x 13	750	68	0.22	0.12	L3	-	99411E3
	1000	12.5 x 12.5 x 16	900	100	0.22	0.09	L2	97412E3	-
	1000	12.5 x 12.5 x 16	900	100	0.22	0.09	L4	-	99412E3
	2200	16 x 16 x 16	1000	220	0.24	0.08	L5	-	99413E3
	3300	16 x 16 x 21	1200	330	0.24	0.06	L5	-	99414E3
	3300	18 x 18 x 16	1200	330	0.26	0.08	L5	-	99415E3
4700	18 x 18 x 21	1550	470	0.28	0.06	L5	-	99416E3	
16	150	8 x 8 x 10	180	24	0.22	0.40	L1	97502E3	-
	330	10 x 10 x 14	430	53	0.22	0.20	L1	97501E3	-
	470	12.5 x 12.5 x 13	750	75	0.18	0.12	L2	97511E3	-
	470	12.5 x 12.5 x 13	750	75	0.18	0.12	L3	-	99511E3
	680	12.5 x 12.5 x 16	900	108	0.18	0.09	L2	97512E3	-
	680	12.5 x 12.5 x 16	900	108	0.18	0.09	L4	-	99512E3
	1000	16 x 16 x 16	1100	160	0.18	0.08	L5	-	99513E3
	1000	16 x 16 x 21	1200	160	0.18	0.06	L5	-	99514E3
	1500	16 x 16 x 16	1100	240	0.18	0.08	L5	-	99515E3
	1500	18 x 18 x 16	1200	240	0.18	0.08	L5	-	99516E3
	2200	16 x 16 x 21	1200	352	0.20	0.06	L5	-	99517E3
	2200	18 x 18 x 21	1550	352	0.20	0.06	L5	-	99518E3
	3300	18 x 18 x 21	1550	528	0.22	0.06	L5	-	99519E3
25	100	8 x 8 x 10	180	25	0.18	0.40	L1	97602E3	-
	220	10 x 10 x 10	300	55	0.18	0.25	L1	97601E3	-
	220	10 x 10 x 10	300	55	0.18	0.25	L1	-	99601E3
	330	12.5 x 12.5 x 13	750	82	0.16	0.12	L2	97611E3	-
	330	12.5 x 12.5 x 13	750	82	0.16	0.12	L3	-	99611E3
	470	12.5 x 12.5 x 16	900	117	0.16	0.09	L2	97612E3	-
	470	12.5 x 12.5 x 16	900	117	0.16	0.09	L4	-	99612E3
	1000	16 x 16 x 16	1100	250	0.16	0.08	L5	-	99613E3
	1000	16 x 16 x 21	1200	250	0.16	0.06	L5	-	99614E3
	1500	16 x 16 x 21	1200	375	0.16	0.06	L5	-	99615E3
	1500	18 x 18 x 16	1200	375	0.16	0.08	L5	-	99616E3
	2200	18 x 18 x 21	1550	550	0.18	0.06	L5	-	99617E3

**Notes**

- (1) Standard reflow soldering profile, see Fig. 4 and Table 4
- (2) Advanced reflow soldering profile, according to JEDEC J-STD-020, see Fig. 5 and Table 5
- (3) Determines the applicable row in the table "Endurance Test Duration and Useful Life"



ELECTRICAL DATA AND ORDERING INFORMATION									
U <sub>R</sub> (V)	C <sub>R</sub> (µF)	NOMINAL CASE SIZE L x W x H (mm)	I <sub>R</sub> 100 kHz 125 °C (mA)	I <sub>L2</sub> 2 min (µA)	tan δ 100 Hz	Z 100 kHz 20 °C (Ω)	LIFE CODE <sup>(3)</sup>	ORDERING CODE <sup>(1)</sup> MAL2140...	ORDERING CODE <sup>(2)</sup> MAL2140...
35	68	8 x 8 x 10	180	24	0.14	0.40	L1	97003E3	-
	100	10 x 10 x 10	255	35	0.14	0.25	L1	97001E3	-
	100	10 x 10 x 10	255	35	0.14	0.25	L1	-	99001E3
	150	10 x 10 x 14	317	53	0.14	0.20	L1	97002E3	-
	220	12.5 x 12.5 x 13	750	77	0.14	0.12	L2	97011E3	-
	220	12.5 x 12.5 x 13	750	77	0.14	0.12	L3	-	99011E3
	330	12.5 x 12.5 x 13	750	115	0.14	0.12	L2	97012E3	-
	330	12.5 x 12.5 x 13	750	115	0.14	0.12	L3	-	99012E3
	470	12.5 x 12.5 x 16	900	164	0.14	0.09	L2	97013E3	-
	470	12.5 x 12.5 x 16	900	164	0.14	0.09	L4	-	99013E3
	680	16 x 16 x 16	1100	238	0.14	0.08	L5	-	99014E3
	820	16 x 16 x 21	1200	287	0.14	0.06	L5	-	99015E3
	1000	18 x 18 x 16	1200	350	0.14	0.08	L5	-	99016E3
	1200	18 x 18 x 21	1550	420	0.14	0.06	L5	-	99017E3
1500	18 x 18 x 21	1550	525	0.14	0.06	L5	-	99018E3	
50	47	8 x 8 x 10	145	24	0.14	0.70	L1	97103E3	-
	68	10 x 10 x 10	205	34	0.14	0.50	L1	97101E3	-
	68	10 x 10 x 10	205	34	0.14	0.50	L1	-	99101E3
	100	10 x 10 x 14	255	50	0.14	0.40	L1	97102E3	-
	220	12.5 x 12.5 x 13	750	110	0.12	0.23	L2	97111E3	-
	220	12.5 x 12.5 x 13	750	110	0.12	0.23	L3	-	99111E3
	330	12.5 x 12.5 x 16	900	165	0.12	0.18	L2	97112E3	-
	330	12.5 x 12.5 x 16	900	165	0.12	0.18	L4	-	99112E3
	470	16 x 16 x 16	900	235	0.12	0.15	L5	-	99113E3
	680	16 x 16 x 21	1000	340	0.12	0.13	L5	-	99114E3
	680	18 x 18 x 16	1000	340	0.12	0.15	L5	-	99115E3
	820	18 x 18 x 16	1000	410	0.12	0.15	L5	-	99116E3
	820	18 x 18 x 21	1050	410	0.12	0.13	L5	-	99117E3
	1000	18 x 18 x 21	1050	500	0.12	0.13	L5	-	99118E3
63	10	8 x 8 x 10	145	6.3	0.12	0.70	L1	97805E3	-
	22	8 x 8 x 10	145	14	0.12	0.70	L1	97803E3	-
	33	8 x 8 x 10	145	21	0.12	0.70	L1	97804E3	-
	47	10 x 10 x 10	205	30	0.12	0.50	L1	97801E3	-
	47	10 x 10 x 10	205	30	0.12	0.50	L1	-	99801E3
	68	10 x 10 x 14	255	43	0.12	0.40	L1	97802E3	-
	100	12.5 x 12.5 x 13	500	63	0.10	0.25	L2	97811E3	-
	100	12.5 x 12.5 x 13	500	63	0.10	0.25	L3	-	99811E3
	220	12.5 x 12.5 x 16	600	138	0.10	0.20	L2	97812E3	-
	220	12.5 x 12.5 x 16	600	138	0.10	0.20	L4	-	99812E3
	330	16 x 16 x 16	700	208	0.10	0.18	L5	-	99813E3
	330	16 x 16 x 21	750	208	0.10	0.15	L5	-	99814E3
	330	18 x 18 x 16	750	208	0.10	0.18	L5	-	99815E3
	470	16 x 16 x 21	750	296	0.10	0.15	L5	-	99816E3
	470	18 x 18 x 16	750	296	0.10	0.18	L5	-	99817E3
	470	18 x 18 x 21	900	296	0.10	0.15	L5	-	99818E3
	680	18 x 18 x 21	900	428	0.10	0.15	L5	-	99819E3

Notes

- (1) Standard reflow soldering profile, see Fig. 4 and Table 4
- (2) Advanced reflow soldering profile, according to JEDEC J-STD-020, see Fig. 5 and Table 5
- (3) Determines the applicable row in the table "Endurance Test Duration and Useful Life"



**Table 7**

ADDITIONAL ELECTRICAL DATA		
PARAMETER	CONDITIONS	VALUE
<b>Voltage</b>		
Surge voltage for short periods	IEC 60384-18, subclause 4.14	$U_s \leq 1.15 \times U_R$
Reverse voltage for short periods	IEC 60384-18, subclause 4.16	$U_{rev} \leq 1 V$
<b>Current</b>		
Leakage current	After 2 min at $U_R$	$I_{L2} \leq 0.01 \times C_R \times U_R$
<b>Inductance</b>		
Equivalent series inductance (ESL)	$\varnothing D = 8 \text{ mm}$	Typ. 6 nH
	$\varnothing D = 10 \text{ mm}$	Typ. 8 nH
	$\varnothing D \geq 12.5 \text{ mm}$	Typ. 11 nH
<b>Resistance</b>		
Equivalent series resistance (ESR) at 100 Hz	Calculated from $\tan \delta_{max.}$ and $C_R$ (see Table 6)	$ESR = \tan \delta / 2\pi f C_R$

**CAPACITANCE (C)**

Fig. 6 - Typical multiplier of capacitance as a function of ambient temperature

**DISSIPATION FACTOR ( $\tan \delta$ )**

 Fig. 7 - Typical multiplier of dissipation factor ( $\tan \delta$ ) as a function of ambient temperature

**EQUIVALENT SERIES RESISTANCE (ESR)**

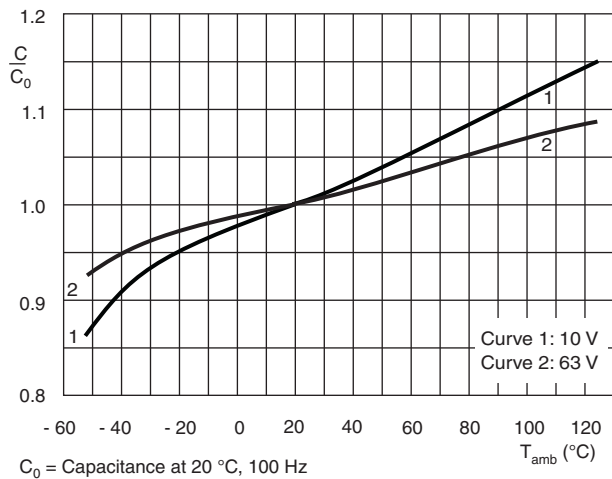
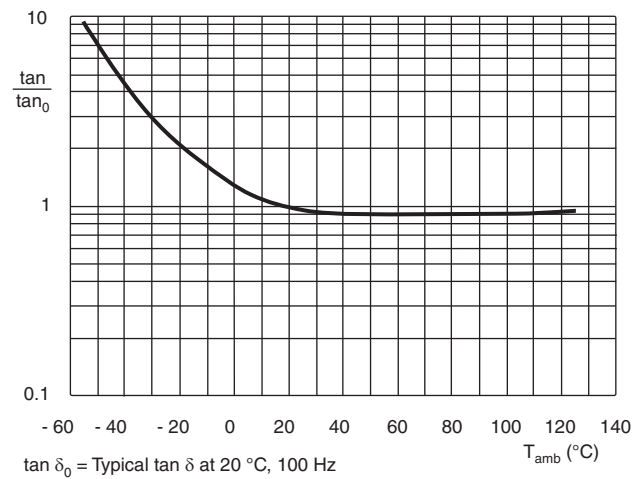
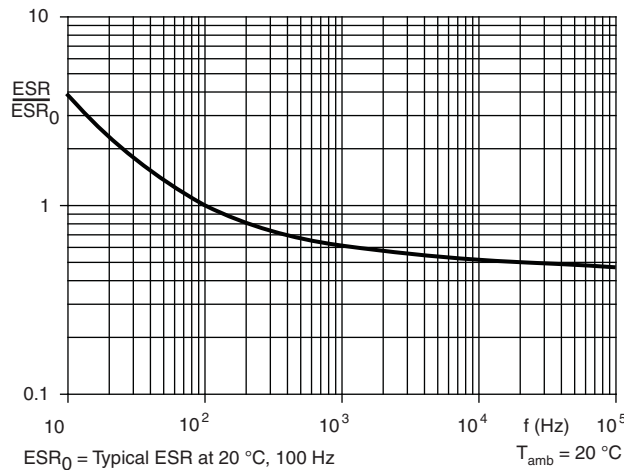

Fig. 8 - Typical multiplier of ESR as a function of frequency

**IMPEDANCE (Z)**

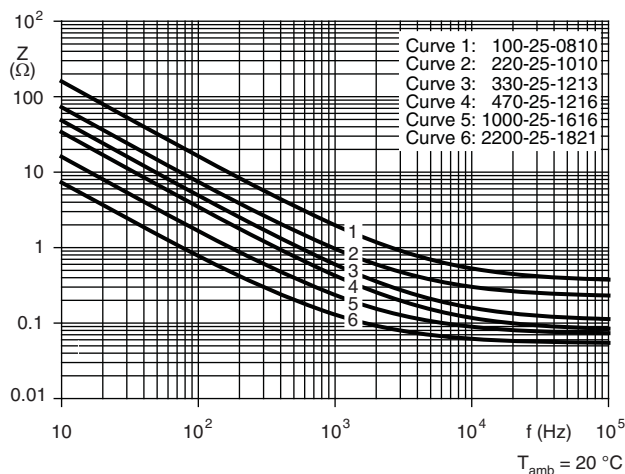

Fig. 9 - Typical impedance as a function of frequency

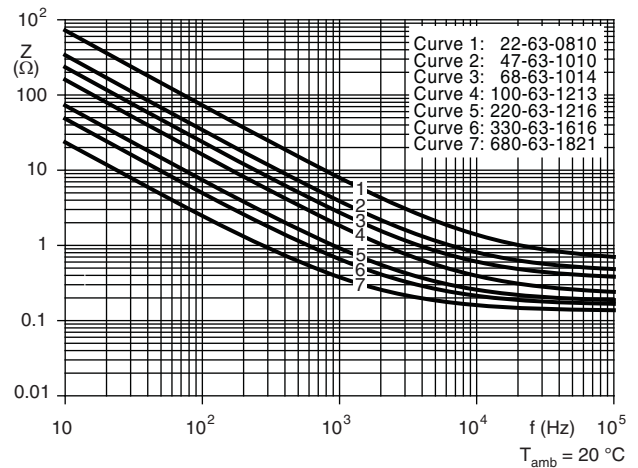

Fig. 10 - Typical impedance as a function of frequency

**RIPPLE CURRENT AND USEFUL LIFE**

Table 8

ENDURANCE TEST DURATION AND USEFUL LIFE			
LIFE CODE	ENDURANCE AT 125 °C (h)	USEFUL LIFE AT 125 °C (h)	USEFUL LIFE AT 40 °C 1.8 x I <sub>R</sub> APPLIED (h)
L1	1000	1500	150 000
L2	2000	3000	300 000
L3	3000	3500	350 000
L4	4000	5000	400 000
L5	5000	6000	500 000

**Note**

- Multiplier of useful life code: MBC242

MBC242

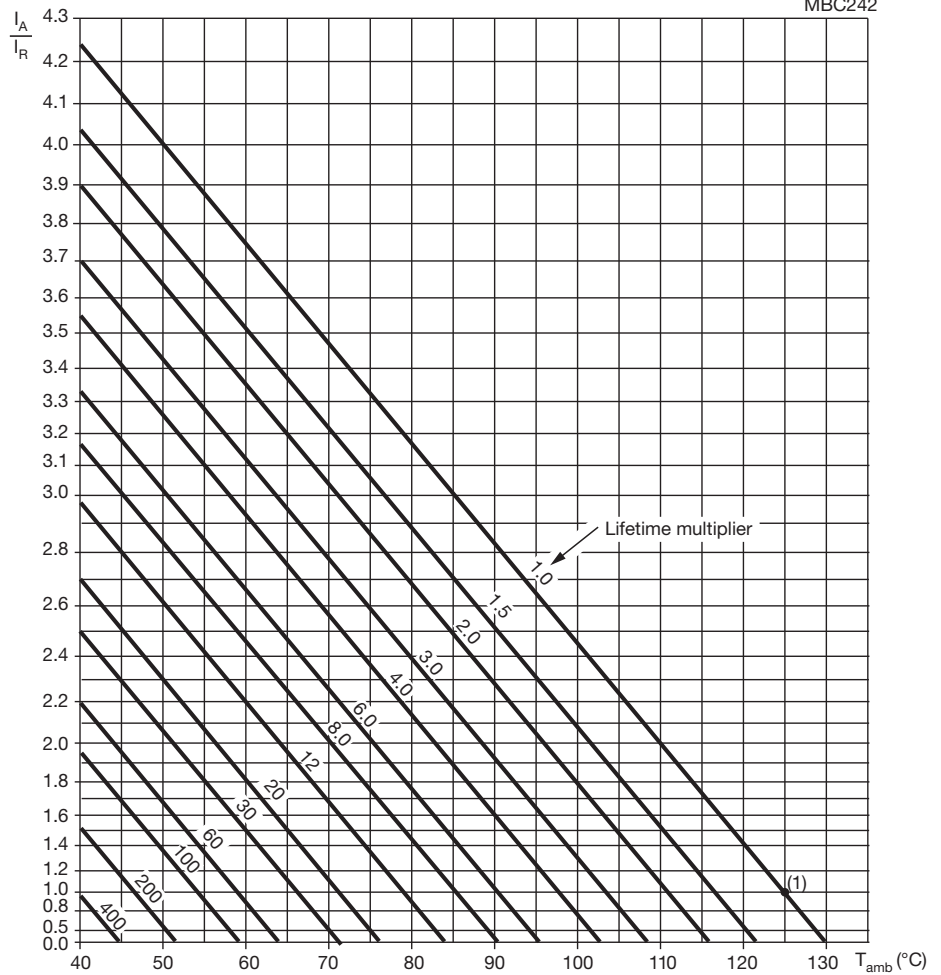

$I_A$  = Actual ripple current at 100 kHz  
 $I_R$  = Rated ripple current at 100 kHz, 125 °C  
 (1) Useful life at 125 °C and  $I_R$  applied; see Table 8

Fig. 11 - Multiplier of useful life as a function of ambient temperature and ripple current load

Table 9

MULTIPLIER OF RIPPLE CURRENT ( $I_R$ ) AS A FUNCTION OF FREQUENCY								
$U_R$ (V)	FREQUENCY (Hz)							
	50	100	300	1000	3000	10 000	30 000	100 000
	$I_R$ MULTIPLIER							
6.3	0.60	0.70	0.80	0.85	0.90	0.95	0.97	1.00
10	0.60	0.70	0.80	0.85	0.90	0.95	0.97	1.00
16	0.60	0.70	0.80	0.85	0.90	0.95	0.97	1.00
25	0.60	0.70	0.80	0.85	0.90	0.95	0.97	1.00
35	0.45	0.60	0.75	0.85	0.90	0.95	0.97	1.00
50	0.45	0.60	0.75	0.85	0.90	0.95	0.97	1.00
63	0.40	0.55	0.70	0.85	0.90	0.95	0.97	1.00



Table 10

TEST PROCEDURES AND REQUIREMENTS			
TEST		PROCEDURE (quick reference)	REQUIREMENTS
NAME OF TEST	REFERENCE		
Mounting	IEC 60384-18, subclause 4.3	Shall be performed prior to tests mentioned below; reflow soldering; for maximum temperature load refer to chapter "Mounting"	$\Delta C/C: \pm 5 \%$ $\tan \delta \leq \text{spec. limit}$ $I_{L2} \leq \text{spec. limit}$
Endurance	IEC 60384-18 / CECC 32300, subclause 4.15	$T_{\text{amb}} = 125 \text{ }^\circ\text{C}$ ; $U_R$ applied; for test duration see Table 8	$U_R = 6.3 \text{ V}$ ; $\Delta C/C: \pm 25 \%$ $U_R \geq 10 \text{ V}$ ; $\Delta C/C: \pm 20 \%$ $\tan \delta \leq 2 \times \text{spec. limit}$ $I_{L2} \leq \text{spec. limit}$
Useful life	CECC 30301, subclause 1.8.1	$T_{\text{amb}} = 125 \text{ }^\circ\text{C}$ ; $U_R$ and $I_R$ applied; for test duration see Table 8	$\Delta C/C: \pm 30 \%$ $\tan \delta \leq 3 \times \text{spec. limit}$ $I_{L2} \leq \text{spec. limit}$ no short or open circuit total failure percentage: $\leq 1 \%$
Shelf life (storage at high temperature)	IEC 60384-18 / CECC 32300, subclause 4.17	$T_{\text{amb}} = 125 \text{ }^\circ\text{C}$ ; no voltage applied; 1000 h after test: $U_R$ to be applied for 30 min, 24 h to 48 h before measurement	For requirements see "Endurance test" above
Reverse voltage	IEC 60384-18 / CECC 32300, subclause 4.16	$T_{\text{amb}} = 125 \text{ }^\circ\text{C}$ ; 125 h at $U = -0.5 \text{ V}$ , followed by 125 h at $U_R$	$\Delta C/C: \pm 15 \%$ $\tan \delta \leq 1.5 \times \text{spec. limit}$ $I_{L2} \leq \text{spec. limit}$

Statements about product lifetime are based on calculations and internal testing. They should only be interpreted as estimations. Also due to external factors, the lifetime in the field application may deviate from the calculated lifetime. In general, nothing stated herein shall be construed as a guarantee of durability.



## **Disclaimer**

ALL PRODUCT, PRODUCT SPECIFICATIONS AND DATA ARE SUBJECT TO CHANGE WITHOUT NOTICE TO IMPROVE RELIABILITY, FUNCTION OR DESIGN OR OTHERWISE.

Vishay Intertechnology, Inc., its affiliates, agents, and employees, and all persons acting on its or their behalf (collectively, "Vishay"), disclaim any and all liability for any errors, inaccuracies or incompleteness contained in any datasheet or in any other disclosure relating to any product.

Vishay makes no warranty, representation or guarantee regarding the suitability of the products for any particular purpose or the continuing production of any product. To the maximum extent permitted by applicable law, Vishay disclaims (i) any and all liability arising out of the application or use of any product, (ii) any and all liability, including without limitation special, consequential or incidental damages, and (iii) any and all implied warranties, including warranties of fitness for particular purpose, non-infringement and merchantability.

Statements regarding the suitability of products for certain types of applications are based on Vishay's knowledge of typical requirements that are often placed on Vishay products in generic applications. Such statements are not binding statements about the suitability of products for a particular application. It is the customer's responsibility to validate that a particular product with the properties described in the product specification is suitable for use in a particular application. Parameters provided in datasheets and / or specifications may vary in different applications and performance may vary over time. All operating parameters, including typical parameters, must be validated for each customer application by the customer's technical experts. Product specifications do not expand or otherwise modify Vishay's terms and conditions of purchase, including but not limited to the warranty expressed therein.

Except as expressly indicated in writing, Vishay products are not designed for use in medical, life-saving, or life-sustaining applications or for any other application in which the failure of the Vishay product could result in personal injury or death. Customers using or selling Vishay products not expressly indicated for use in such applications do so at their own risk. Please contact authorized Vishay personnel to obtain written terms and conditions regarding products designed for such applications.

No license, express or implied, by estoppel or otherwise, to any intellectual property rights is granted by this document or by any conduct of Vishay. Product names and markings noted herein may be trademarks of their respective owners.